

8 5/8"

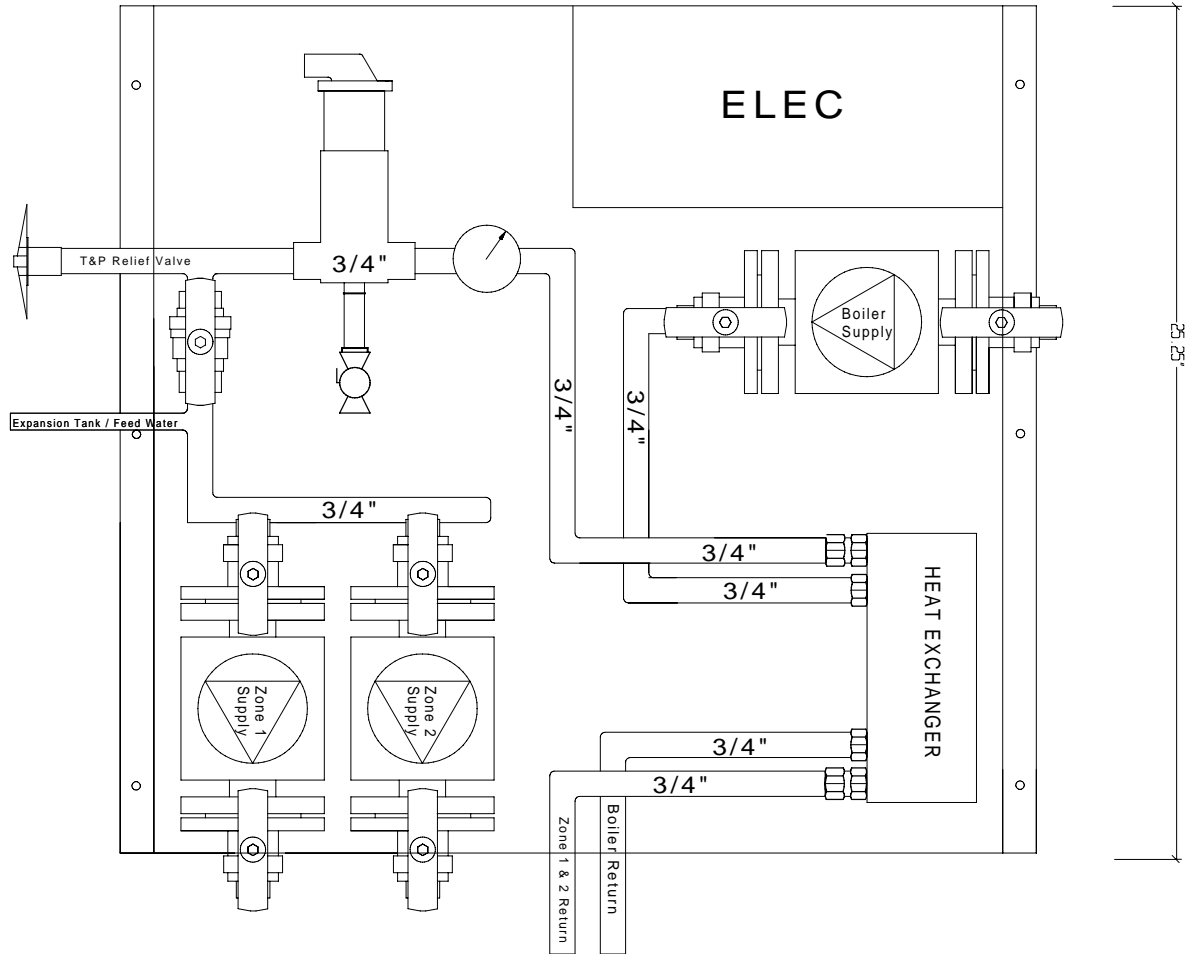





SIDE VIEW

27.25"



25.25"

Legend

-  CIRCULATORS WITH SPRING CHECK VALVE
-  THERMOSTATIC MIXING VALVE
-  T & P RELIEF VALVE
-  TRIDICATOR
-  ISOLATION VALVE
-  AIR VENT
-  PURGE VALVE



DO NOT SCALE DRAWING, DIMENSIONS ARE IN INCHES

Drawn by:
BR
Part Number: HP100020-2
HP100030-2 HP100050-2

Type:
Heat Exchanger Station
Model Number:
HES-20-2 HES-30-2 HES-50-2